

# Zero Defects

Entegris Newsletter

May 2017

## CONTENTS

### 1. Entegris News

- [Entegris Acquires Microelectronics Filtration Product Line from W. L. Gore & Associates](#)
- [Entegris Partners with China's Spectrum Materials to Manufacture Entegris Specialty Chemicals in China](#)

### 2. Innovation

- [Gas Purge or Wet Cleaning? Decontamination Solutions to Control AMCs in FOU Ps](#)

### 4. Process Improvement

- [Development of Novel Purifiers with Appropriate Functional Groups Based on Solvent Polarities at Bulk Filtration](#)

### 7. Yield Improvement

- [Evaluation of Post Etch Residue Cleaning Solutions for the Removal of TiN Hardmask](#)

### 9. Product Highlight

- [ProE-Vap® 200 Delivery System: Effective Delivery of Solid Materials](#)

## ENTEGRIS NORTH AMERICA

A question about Entegris products?  
Call your customer service center

T +1 952 556 4181  
T 800 394 4083 (toll free)  
F +1 952 556 8022  
F 800 763 5820 (toll free)

[www.entegris.com](http://www.entegris.com)  
Publisher: Entegris North America  
Editor: Françoise Moign  
Contact [francoise.moign@entegris.com](mailto:francoise.moign@entegris.com) for permission to reproduce Zero Defects articles

## Entegris Acquires Microelectronics Filtration Product Line from W. L. Gore & Associates

Entegris acquired W. L. Gore & Associates' water and chemical filtration product line for microelectronics applications in an asset purchase for approximately \$20 million. Entegris expects the transaction to be accretive to earnings beginning in 2017.

Todd Edlund, Chief Operating Officer of Entegris, said: "We are excited to add these market-leading filtration solutions to our existing offerings for the microfiltration of high-purity water and bulk chemicals used in

semiconductor, OLED and flat panel display manufacturing applications. The acquisition of these products complements our portfolio of advanced liquid filtration solutions. It also reflects our strategy to grow our served markets through the deployment of capital for strategic accretive acquisitions that augment our internal development initiatives."

For more information about these products, please see [www.entegris.com/newfilters](http://www.entegris.com/newfilters)

## Entegris Partners with China's Spectrum Materials to Manufacture Entegris Specialty Chemicals in China

Entegris has signed an agreement with Spectrum Materials (Fujian) Co., Ltd. to expand its presence in China. According to the agreement, Spectrum Materials, a manufacturer and distributor of specialty chemicals, will manufacture Entegris specialty chemicals products at Spectrum Materials' Quanzhou facility.

"We are excited about this partnership, as it will significantly improve our capabilities to meet growing demands for specialty chemicals in the industries we serve," stated Entegris Senior Vice President of Specialty Chemicals and Engineered Materials, Stuart Tison. "Spectrum Materials is a well-established company in China that has experience supplying related high-purity chemicals and shares our expectations for quality and manufacturing standards. As we have done in other global regions, we continue to look for ways to better serve our customers and to add value with local collaboration, business processes and resources."

Entegris currently manufactures specialty chemicals in both the U.S. and South Korea and has business operations in Beijing, Shanghai and Xi'an, China. The partnership with Spectrum Materials will expand its capability in China and shorten its supply chain for Chinese customers. This relationship is part of a broader strategic commitment by Entegris to support the growing semiconductor and related microelectronics industries in China.

"We are pleased to partner with Entegris in the manufacturing of its industry-leading specialty chemical products in China," said President of Spectrum Materials, Guofu Chen. "Our new expansion, combined with Entegris manufacturing technology, establishes a world-class facility for the production of Entegris' semiconductor-grade specialty chemicals in China."

[Read more >>](#)

# Gas Purge or Wet Cleaning? Decontamination Solutions to Control AMCs in FOUPs

By Paola Gonzalez-Aguirre Ph.D., Engineer II, CEA/LETI assignee – Entegris, Inc.

Airborne Molecular Contaminants (AMCs) pose remarkable yield threats, and their concentrations from part-per-trillion (ppt) to part-per-billion (ppb) levels can seriously damage electronic devices throughout the IC manufacturing process. Front Opening Unified Pods (FOUPs) are designed as controlled microenvironments (MEs) that protect processed wafers from AMCs during storage and transport. However, contamination issues still exist since FOUPs are constituted of polymeric materials that are known to not only outgas AMCs but also sorb volatile compounds introduced during wafer processing and later release them as molecular contaminants onto stored wafers, recognized as cross contamination chain. The available literature does not provide much information about the impact gas purge has on AMC control inside a FOUP and concerning FOUP aqueous wet cleaning no available information is public.

This paper, presented at [SPCC 2017](#), discusses two AMC decontamination and control scenarios for FOUPs, namely, aqueous wet cleaning and inert gas purge respectively, and the effect these solutions have on HF volatile acid cross-contamination of Cu-coated wafers stored inside FOUPs of different polymer types.

## FOUPS AND POLYMERS MATERIALS TESTED

The three containers tested are commercial Entegris FOUPs composed of four different polymers (see following table):

FOUP tested	FOUP platform	Shell material	Wafer capacity	Side columns material	Inner door material	Wafer planes material
PC	Spectra™	PC	25+1	PC	PC/CP	PEEK-CF
PC/CP	Spectra-S	PC/CP	25+1	PC/CP	PC/CP	PEEK-CF
EBM/CNT	A300™	EBM/CNT	25	EBM/CNT	EBM/CNT	EBM/CNT

PC: Ultrapure polycarbonate | EBM/CNT: Entegris Barrier Material/Carbon-nanotubes  
 PC/CP: STAT-PRO® 500 carbon-filled PC | PEEK/CF: carbon fiber polyetheretherketone

## EXPERIMENTAL

FOUPs were first conditioned at cleanroom conditions (21 ±2°C, 45 ±5% RH). To contaminate the FOUP a 10 µL droplet of HF 2% (1.15E-5 mol) is deposited into a PTFE cup, and then placed into the FOUP for two hours. Considering 28 liters of the FOUP volume, the full evaporation of the microdroplet leads theoretically to 9.2 ppmv of HF in the air. Wafers used for the test are

200 mm silicon wafers with a copper layer (100 nm PVD deposition). After the two hours of contamination, six 200 mm Cu wafers were placed and exposed on top of 300 mm silicon wafers (in slots 01, 02, 12, 13, 24 and 25). The FOUPs were purged continuously using 5 L/min of clean dry air for 24 hours.

For wet clean test, after two hours of contamination FOUPs were cleaned using a DMS M300 in an Entegris Process of Record (POR) recipe of 45 minutes. Wet cleaning test were performed varying time (0, 4 and 22 hours) after the contamination event. Once the FOUPs were cleaned, a waiting step (door closed) of 3 hours occurred. Then to evaluate the cleaning effectivity, one single Cu wafer was stored over a weekend (66 hours) into the FOUPs.

HF deposited on wafers was collected by a Liquid Phase Extraction (LPE) of the surface using a low volume of deionized water and analysis of the solution by Ionic Chromatography (IC) with low limits of detection better than 5E+11 ions/cm².

## RESULTS

### Gas Purge

HF transfer from contaminated non-purged FOUPs and purged FOUPs, to Cu wafers at different exposure times (2 hours, 24 hours) and in three different wafer locations bottom (slots 1 and 2), middle (slots 12 and 13) and upper (slots 24 and 25) were determined. **Non-purged results confirm the significant HF cross-contamination from contaminated FOUP to Cu surfaces as well as the effectiveness of the Entegris barrier material (EBM/CNT) in comparison to polycarbonate and polycarbonate composite with respect to the lower rate of HF transfer on stored Cu wafers especially after 24 hours of exposure (7.1E+13 vs 4.4E+14 F- atoms/cm²), below the ITRS recommendations for AMC's (<1E+14 F-/cm²).** **Regarding the implementation of continuous purge (5 L/min), the process has an important reduction in the transfer of HF from the FOUP polymer to the Cu wafer; with the exception of the PC FOUP in the upper slot. Indeed, contamination levels decrease about a factor ~6 over 24 hours for PC ~2 for PC/CP and almost no HF transfer is shown in the case of EBM/CNT.**

*continued on the next page*

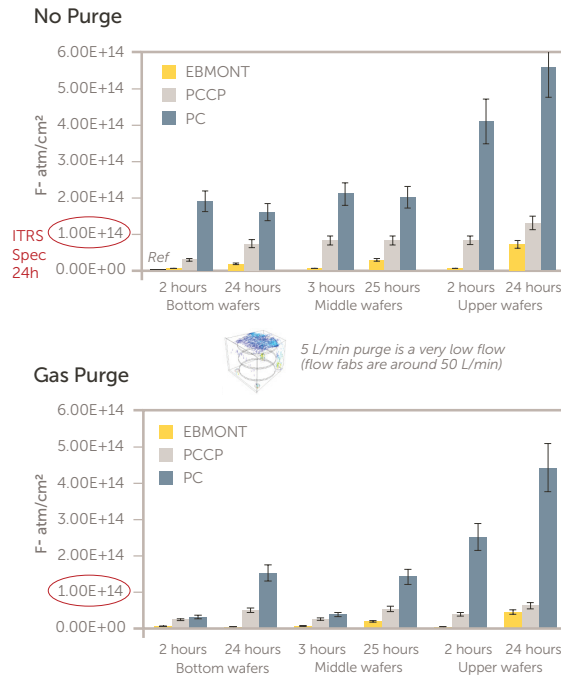

Figure 1. HF transfer to Cu-coated wafers after intentional contamination, without purge and with 5 L/min purge.

A 5 L/min dry clean air purge is a very low flow, and can be considered as a purge maintain flow. Purge flow in Fabs are around 50 L/min.

**Wet Cleaning**

For wet cleaning test, the materials evaluated were those with the opposite behavior, meaning the high and very low outgassing/transfer. Then, only PC and EBM/CNT were tested. Both FOUP polymer materials (PC and EBM/CNT) exhibit very similar results.

First, there is an obvious contamination diminution when wet clean decontamination solution is used with respect to a non-cleaned FOUP, meaning a contamination reduction between 40–60% in a PC FOUP and around 70% in a EBM/CNT FOUP. Second, there is a slight decrease when cleaning process is applied with a longer q-time, being barely significant in the case of the EBM/CNT material. However, the relative gain in terms of HF transfer on Cu wafer is better when cleaning process happen for shorter q-time as shown on figure 3.

Indeed, depending on the time before cleaning, different concentration gradients are established and wet cleaning is able to remove the contamination in the near surface, promoting sorption/desorption. Upon wafer storage, this equilibrium is disturbed by the presence of the wafers modifying the concentration gradient and the cross-contamination phenomenon appears. Results shown, that in terms of HF transfer from FOUP to wafer, the shorter q-time, the better improvement can be expected on the contamination transfer at the wafer level.

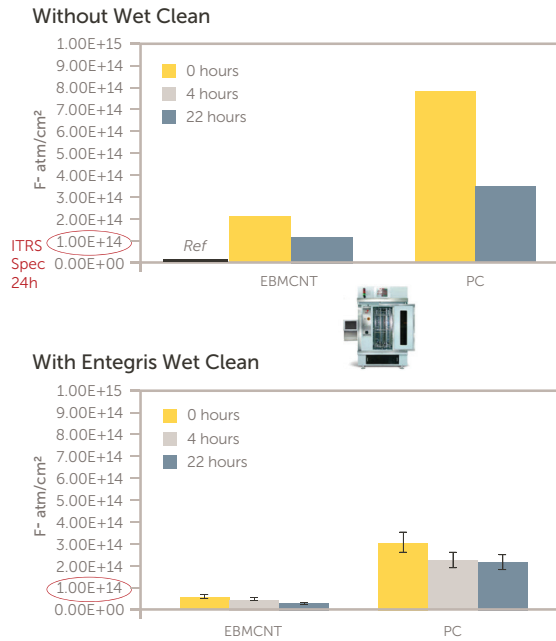

Figure 2. HF transfer to Cu-coated wafers after intentional contamination, without wet clean and after wet clean.

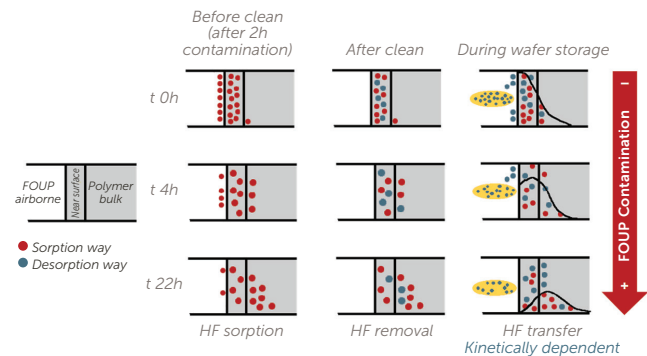

Figure 3. Depending time HF contamination transfer model.

**CONCLUSIONS**

The HF cross-contamination from FOUP to stored wafers was studied for three different FOUP materials with continuous clean gas purge and two FOUP materials for wet cleaning. Continuous FOUP purge appears to be a very effective way to control HF cross-contamination and to guarantee an optimum yield based on low humidity, and a chemically clean environment from the AMC point of view. In addition, the use of FOUPs made of barrier materials such as EBM/CNT allows an excellent control of very low moisture and volatile acids cross-contamination. Wet cleaning solution carried out as close as possible to the contamination event appears as an option to diminish polymer contamination, especially after a high-contaminant process. Then, no single solution can avoid cross contamination, but the combination of purge, wet clean and the use of barrier materials can reduce contamination transfer.

## Development of Novel Purifiers with Appropriate Functional Groups Based on Solvent Polarities at Bulk Filtration

By Tetsu Kohyama, Fumiya Kaneko and Yoshiaki Yamada — Entegris, Japan & Saksatha Ly, James Hamzik, Jad Jaber and Aiwen Wu — Entegris, Inc. U.S.

Today's chemical suppliers and their Original Equipment Manufacturers (OEMs) are feeling the pressure to reduce metal contamination from Integrated Device Manufacturers (IDMs) pushing the envelope with ever-smaller technology nodes. It's anticipated that each metal concentration should be controlled less than 10 ppt in advanced photoresists by 2018. Chemical manufacturers can manufacture ultrapure solvents at single- or sub-ppt level; however, reaching the target specification dictated by the market is still a technical challenge because of the mutual interaction between metal contamination and additives. Actually, traditional methods of metals reduction such as distillation, ion-exchange resins service or water-washing processes need further improvement, particularly for polymer solutions. Also, weak-polar solvents like PGMEA or CHN have recently been used to dissolve more hydrophobic photoresist polymers where current purification technology is inadequate. Under such situation, IDMs have occasionally faced unexpected cone defects and device performance deterioration derived from insufficient metal reduction in raw materials (Shown in Figure 1). Chemical companies continue to seek out innovative purification technology to achieve their challenging specifications.

In this paper, the metal removal efficiency of two tailored membrane technologies was investigated in actual photochemical solvents with different polarities such as Propylene Glycol Monomethyl Ether (PGME), PGMEA and CHN. The result proved that metal removal performance is highly dependent on solvent polarity based on Hansen Solubility Parameters. This analytical approach could bring us to excellent purification strategy.

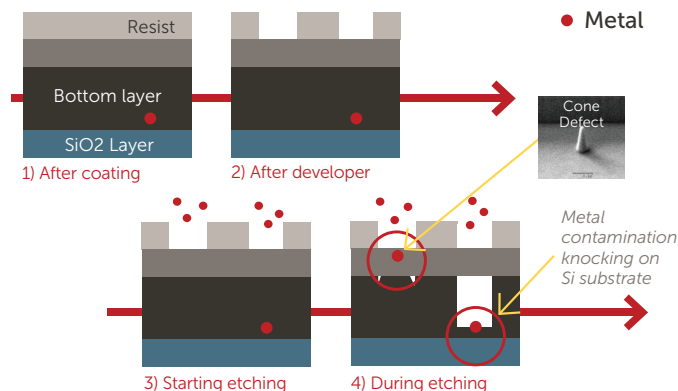

Figure 1. Illustration of metal contamination inducing defects on lithography process.

### Experimental Set Up

The metal challenge solution was first made by adding five ppb of metal analytical standard, an oil-based standard Conostan<sup>®</sup> 21 plus Potassium (K), to test the solvent. Using the test stand shown in Figure 2, filtration was conducted under steady flow by adjusting inlet pressure while monitoring the flow rate of 10 mL/min. Influent and effluent metal concentrations were measured using a standard ICP-MS analytical tool (Agilent<sup>®</sup> 7800s). Each 47 mm coupon two-ply from Protego<sup>®</sup> Plus, Entegris 10 nm rated nylon and two different kinds of purifiers called Purasol<sup>™</sup> SP and SN were used for the test.

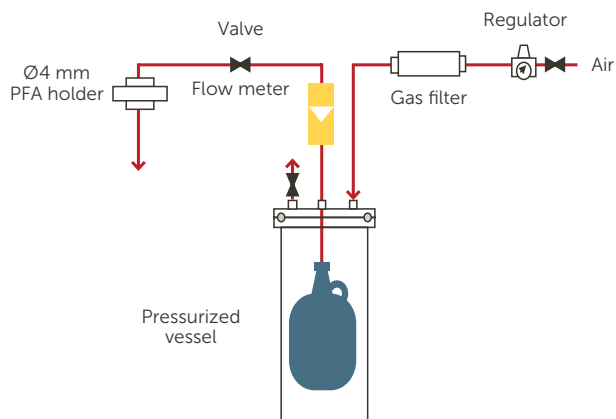

Figure 2. Test stand for metal challenge test.

### Chemical Reaction Investigation

The soaking method was used to evaluate how much Purasol SN and Protego would cause chemical reaction in CHN. Used each sample of Optimizer<sup>®</sup>-D format poured with CHN and extracted the solution one week later for GC-MS analysis (PerkinElmer Clarus<sup>®</sup> 500GC).

## RESULTS AND DISCUSSION

### Metal Reduction and its Metal Removal Mechanism in Lithography Solvents

The graph shown in Figure 3 illustrates that Fe removal capability depends on each solvent polarity. Purasol SP shows the best performance in PGME/PGMEA mixture, while Purasol SN shows better performance in PGMEA and CHN. Figure 4 demonstrates similar behavior in multi-metal removal in PGMEA/PGME.

Therefore, it can be interpreted that Purasol SP is effective in reducing metal contamination in more polar solvents such as PGME/PGMEA mixture, whereas Purasol SN is more suitable in less polar solvents such as PGMEA and CHN.<sup>1</sup>

*continued on the next page*

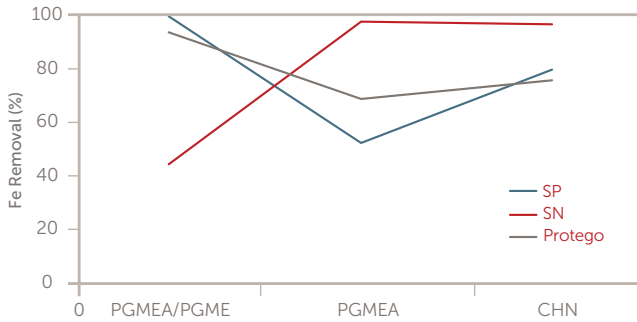

Figure 3. Fe removal performance dependency on each solvent polarity.\*

\* The data on other metals is not shown to see easily each performance.

Table 1. Recommendation and polarity for each solvent.

SOLVENT	POLARITY*	RECOMMENDATION
PGME/PGMEA = (7.3)	80	Purasol PN
PGMEA	64	Purasol SN
CHN	32	Purasol SN

\* Calculated by  $\sqrt{DH^2 + DP^2}$ . dP stands for polarity and dH hydrogen bonding of HSP respectively.

**Metal Removal Efficiency of Purasol SP and SN in PGMEA/PGME**

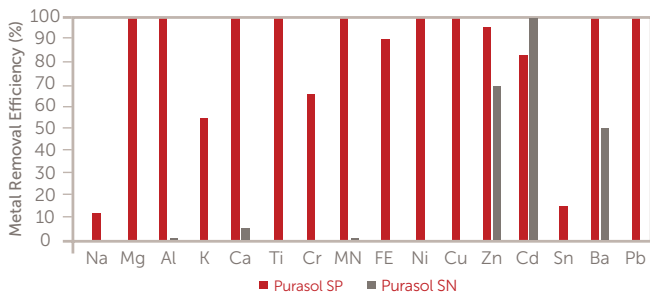

Figure 4. Multi-metal removal efficiency of Purasol SP and SN in PGMEA/PGME mixture.

**Metal Reduction in Photochemical Solutions**

The results shown in Figure 5 further illustrates that Purasol SN could work effectively in less polar solvents such as PGMEA with customer’s photoresist polymer. As mentioned, in general it’s the most challenging to reduce metal contamination in polymer solutions. However, this result may indicate the following assumption that additives can combine with metal contamination, especially transition metals to form aggregates as a core of those metals, which means that its polymer property will shift to much more hydrophilicity after aggregation, even if they are hydrophobic property in nature. Therefore, this adsorption would occur under the same mechanism as PGMEA and CHN.

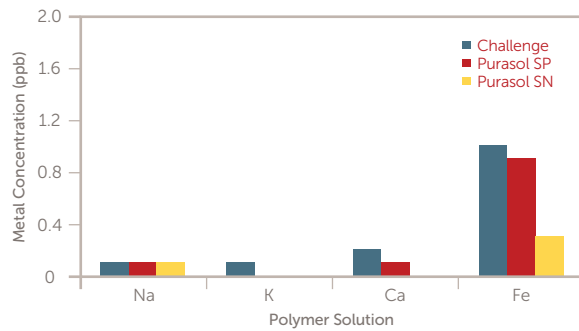

Figure 5. Metal removal testing in a photoresist polymer solution.\*

\* JSR provided this data.

**Compatibility Study of Various Purifiers in Cyclohexanone**

It is known that current Protego purifiers are not fully compatible with ketone solvents such as Cyclohexanone. The GC-MS shown in Figure 6 demonstrates that Protego purification media undergoes chemical reaction with CHN, producing undesirable by-products causing color change in solution from transparency to yellow (Figure 7). On the other hand, Purasol SN proves to be fully compatible with CHN with superior metal removal efficiency as shown in Figure 8. In addition, distillation is a common, yet costly practice to enhance solvent purity. Therefore, Purasol could be a cost-effective alternative to distillation purification.

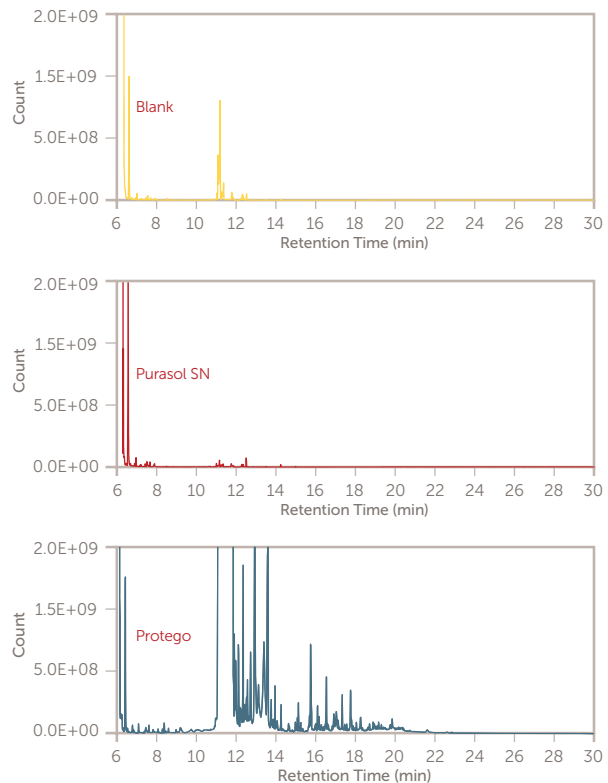

Figure 6. GC-MS chromatography (top: Blank; middle: Purasol SN; bottom: Protego Plus).

continued on the next page



Figure 7. Discoloration of CHN (left: Blank; right: Protego after 1 week soaking).

**Metal Removal Efficiency of Purasol SP in CHN**

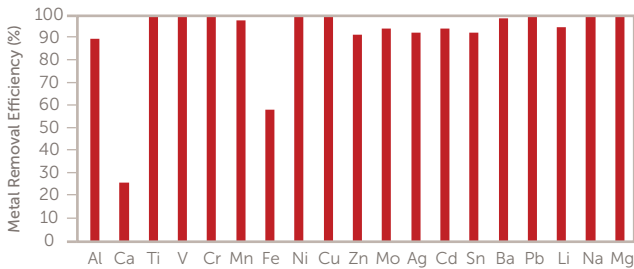

Figure 8. Multi-metal removal efficiency of Purasol SN in cyclohexanone.

**CONCLUSION**

It was found that solvent polarity plays a key role in metal removal performance. Entegris has developed two uniquely tailored purification technologies for total metal reduction in wide range of solvent polarities. Purasol SP was shown to effectively reduce metal contamination in highly polar solvents such as 70:30 mixtures of PGME and PGMEA, while Purasol SN could be effective in less polar solvents such as PGMEA and CHN.

In addition, Purasol SN is more effective in removing metal contamination in PGMEA-based polymer solutions. Although PGMEA and CHN have been employed recently to dissolve resist polymers, they are inadequate and/or not fully compatible with current purification needs. **Therefore Purasol purifiers provide a much needed solution to the technical challenges of metal contamination.**

*Reference:*

<sup>1</sup> Israelachvili, J.N., *Intermolecular and Surface Forces, Second Edition*, McGraw-Hill Education Co., Ltd., 30 (1991).

# Evaluation of Post Etch Residue Cleaning Solutions for the Removal of TiN Hardmask

By Makonnen Payne, Steve Lippy, Ruben Lieten — Entegris, Inc., Els Kesters, Quoc T. Le, Gayle Murdoch, Victor V. Gonzalez and Frank Holsteyns — imec

In the back-end of line (BEOL), dielectric materials are patterned by a dry etch process using a fluorocarbon based plasma, which leads to fluorinated polymer deposition on the dielectric sidewalls. Subsequent metallization requires removal of this polymer to achieve good adhesion between the metallization stack and dielectric and to prevent voiding. The required post-etch residue removal (PERR) wet cleaning step needs to be compatible with a variety of new materials that are introduced in advanced interconnect technology. Formulated cleans have been developed to address the complexity of having exposed dielectric, barrier, liner and line materials and to have a tunable TiN removal rate. In this work we evaluate two types of formulated PERR cleans from Entegris, Inc., the first with compatibility to tungsten and the second with compatibility to copper.

## SCOPE

PERR cleans must etch the TiN hardmask to decrease the aspect ratio of the structure for conformal fill with the contact metal, and remove the residue on the sidewall of the via and trenches to get good adhesion of the contact metal, while being compatible with the exposed liner, barrier, dielectric and contact metal. At the  $\leq 10$  nm node, W is often used in the M1 layer, while Cu is used as the contact metal at every other layer. The potential/pH diagrams for W and Cu (not shown here), make evident that compatible cleans that also etch TiN will need to be in opposite ends of the pH scale. TitanKlean® TK10-X4 is an acidic clean that will be evaluated for W, while TitanKlean TK9C is an alkaline clean targeted at Cu compatibility.

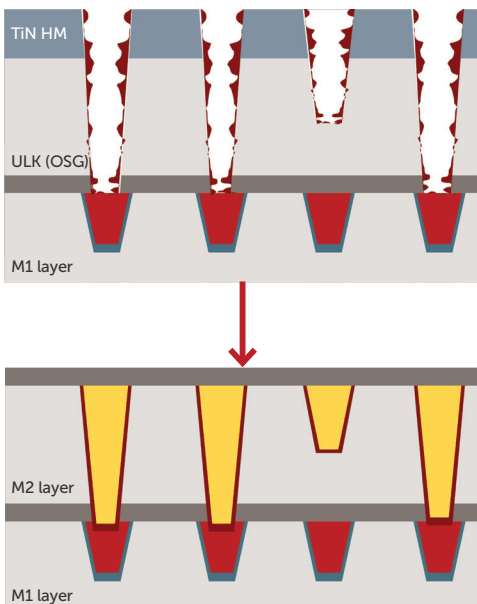

## METHODS

### Material compatibility

Blanket and patterned wafer testing for TK10-X4 was performed on the SCREEN SU3200, a 300 mm single wafer tool, at 60°C at a flow rate of 1.5 L/min. For TK9C, the concentrate was mixed with 30% H<sub>2</sub>O<sub>2</sub> at a dilution ratio of 1:9 by mass to a total mass of 250 g and heated to 50°C in a beaker with agitation (300 rpm). In both cases, a two-minute deionized water (DIW) rinse, three-minute IPA rinse and N<sub>2</sub> blow dry is performed after exposure to the process chemistry. The thickness of the tungsten and electroplated copper blanket films, before and after the experiments, was measured by calibrated XRF. Spectroscopic ellipsometry was used for measuring the thickness of the low- $\kappa$  material and TiN. The low- $\kappa$  material used in this work was an orthosilicate glass (OSG) type of material with a target  $\kappa$ -value of 2.4 (~20% open porosity). The film etch rates were compared to a dilute aqueous hydrofluoric acid (dHF) solution with an HF concentration of 0.05% by weight. The dHF mixture was processed in a beaker at 25°C for comparison to TK9C and TK10-X4.

### Cleaning performance

To assess the performance on patterned structures, a 45 nm  $\frac{1}{2}$  pitch test structure was used. Coupons were immersed in TK10-X4 at 60°C for two minutes in a beaker with agitation (300 rpm), followed by two minutes DIW overflow rinse, three minutes IPA rinse and N<sub>2</sub> dry. The cleaning performance was then evaluated by SEM.

### Electrical performance

The electrical performance and yield for TK10-X4 was evaluated using a 45 nm  $\frac{1}{2}$  pitch test structure with OSG 2.55 dielectric, where the via contact and meander line resistances were measured. The electrical performance and yield for TK9C was evaluated at two different hydrogen peroxide dilutions using a 22 nm  $\frac{1}{2}$  pitch test structure, where Cu-line thicknesses varied from 22 nm to 32 nm.

## RESULTS

### Compatibility

Film type	ETCH RATE (nm/min)	
	0.05% HF	TK10-X4
Plasma-exposed W	0.09	0.12
Plasma-exposed OSG 2.4	0.27	0.09
TiN	0.7	19.7

*continued on the next page*

**YIELD IMPROVEMENT**

Film type	ETCH RATE (nm/min)	
	0.05% HF	TK9C
Plasma-exposed Cu	0.2	<0.1
Plasma-exposed OSG 2.4	0.3	0.4
TiN	0.7	12.9

**TiN Removal/Cleaning Performance**

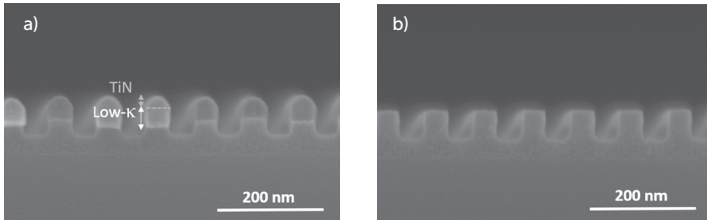

Cross-section SEM image of a) 90 nm pitch patterned wafer with TiN hard mask and low-κ before cleaning; b) after cleaning with TK10-X4.

**Electrical Performance — TK10-X4**

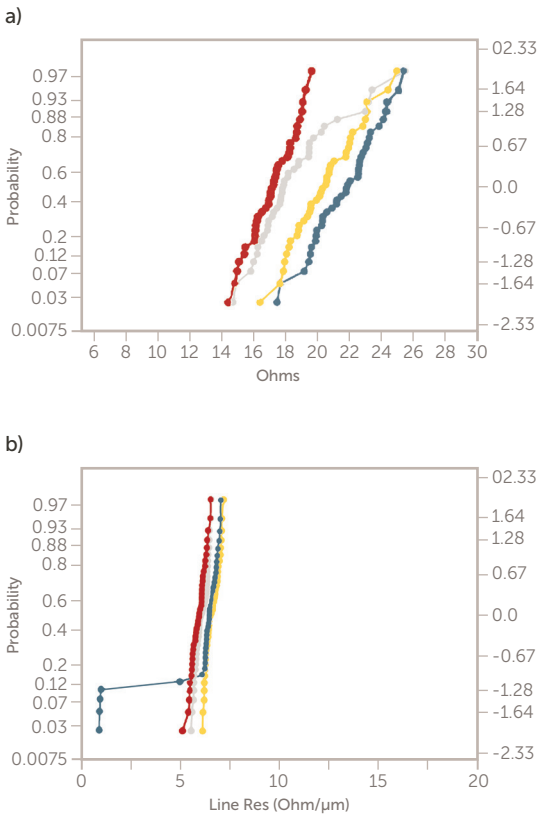

Electrical results for TitanKlean 10-X4 using a 90 nm pitch test structure, highlighting a) via contact resistance and b) meander line resistance. Four wafers were processed with the same conditions.

**Electrical Performance — TK9C**

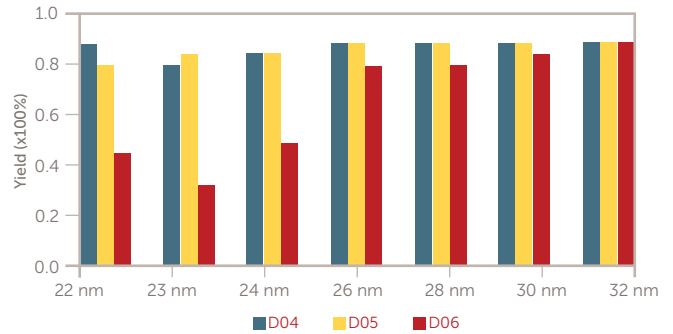

Electrical results for TitanKlean 9C using a 45 nm pitch test structure with CD lines of 22 nm and more. Significant yield improvement for D04 (TitanKlean 9C:H<sub>2</sub>O<sub>2</sub> 1:3, 50°C, two minutes) and D05 (TitanKlean 9C:H<sub>2</sub>O<sub>2</sub> 1:9, 50°C, two minutes) vs. no clean D06 (no clean): 90% vs. 50% for CD lines of 22 nm.

**SUMMARY**

The performance of formulated PERR cleaners, TitanKlean 10-X4 and TitanKlean 9C, developed for ≤10 nm interconnects have been evaluated. The solutions were specifically developed for W and Cu compatibility, respectively. They show compatibility to OSG 2.4, excellent residue removal, as well as tunable TiN hardmask removal. Electrical evaluation of both formulations shows a yield of >90% on the structures tested, a significant improvement over unprocessed wafers.



# ProE-Vap® 200 Delivery System: Effective Delivery of Solid Materials

The ProE-Vap® 200 delivery system is designed for solid precursors used in Atomic Layer Deposition (ALD) and Chemical Vapor Deposition (CVD) processes. It provides a stable mass flux for a wide variety of solid materials used for current and future technology nodes. Solid precursors are difficult to deliver consistently into deposition chambers due to their low vapor pressure and limited thermal stability. The ProE-Vap system overcomes these problems and offers a solution that is unmatched in the industry.



The ProE-Vap delivery system allows for higher transport of solid precursors at lower temperatures more consistently than other vaporizers, thus reducing cost of ownership for ALD and CVD.

It minimizes chemical concentration drifts, allowing for higher wafer throughput with less tool downtime. The ProE-Vap has demonstrated high reliability and robust performance in high-volume manufacturing environments since 2008. It supports delivery of a variety of inorganic and transition metal precursors required in the fabrication of highly complex microelectronic device fabrication.

Available in multiple configurations for installation on different OEM tool sets.

## FEATURES & BENEFITS

- Over seven times higher fill capacity than the ProE-Vap 100
  - Higher flux applications including batch furnaces
  - Less frequent source changes
- Innovative designed ampoule for solid precursor delivery
- Delivers higher mass flux at lower temperature than conventional vaporizers
- Supports pneumatic and manual valve options
- Outstanding overall performance with consistent flux over the vaporizer lifetime
- Proven for multiple solid precursors used in semiconductor applications and can be used for other emerging technologies, such as LED
- Enables efficient usage of precursor and minimizes decomposition from overheating
- Compatible with several OEM tools; supports developmental high-volume wafer processing
- Reduces cost of ownership

## APPLICATIONS

- Atomic layer deposition
  - Chemical vapor deposition
- High-κ capacitors and gate dielectrics
- Metal barriers and electrodes
- Fluorine-free tungsten (FFW)



## Feedback

We value your feedback and suggestions to help us improve Zero Defects. Please send your questions, suggestions and comments to [North\\_America\\_News@entegris.com](mailto:North_America_News@entegris.com). If you would like more information regarding Entegris products and services, please contact your customer service centers (page 1) or refer to Entegris online at [www.entegris.com](http://www.entegris.com)

<b>ZERO DEFECTS ENTEGRIS NEWSLETTER</b>		<b>Free Subscription Form</b>	
		email to <a href="mailto:North_America_News@entegris.com">North_America_News@entegris.com</a>	
		fax to 1 800 763 5820	
Name:*	_____	Job title*:	_____
Company name*:	_____	Dept:	_____
Address:	_____		
Postal code:	_____	City:	_____
		Country:	_____
Tel.:	_____		Send me the Zero Defects pdf file <input type="checkbox"/>
E-mail:*	_____		Send me the direct link of Zero Defects <input type="checkbox"/>
<i>* required to complete</i>			

Entegris®, the Entegris Rings Design™, Pure Advantage™, STAT PRO®, Spectra™, A300™, Protego®, Optimizer®, Purasol™, TitanKlean®, ProE-Vap® and Optimizer® are trademarks of Entegris, Inc.

Clarus® is a trademark of PerkinElmer, Inc.; Agilent® is a trademark of Agilent Technologies; Conostan® is a trademark of SCP Science.

©2017 Entegris, Inc. | All rights reserved. | 9000-8308ENT-0517